

**DESCRIPTION:**

The 529 series is three leaded bicolor light sources designed and white diffused for a variety of applications where dual state illumination is required in the same package.

There are two different chips mounted on a central common cathode lead. Colors can be generated by independently pulse width modulating the chips. The semi-conductor materials used are:  
GaP for (H, G)  
GaAsP/GaP for (E, Y)

**ABSOLUTE MAXIMUM RATINGS: (Ta=25°C)**

Reverse Voltage	5 Volt
Reverse Current (Vr =5V)	100µA
Operating Temperature Range	-40°C To 85°C
Storage Temperature Range	-40°C To 100°C
Lead Soldering Temperature (1.6mm (1/16)From Body)	260°C For 5 Seconds

- NOTES : 1. All dimensions are in millimeters.  
2. Lead spacing is measured where the leads emerge from the package.  
3. Protuded resin under flange is 1.5 mm (0.059") Max.  
4. Specifications are subject to change without notice.

**PACKAGE DIMENSIONS**

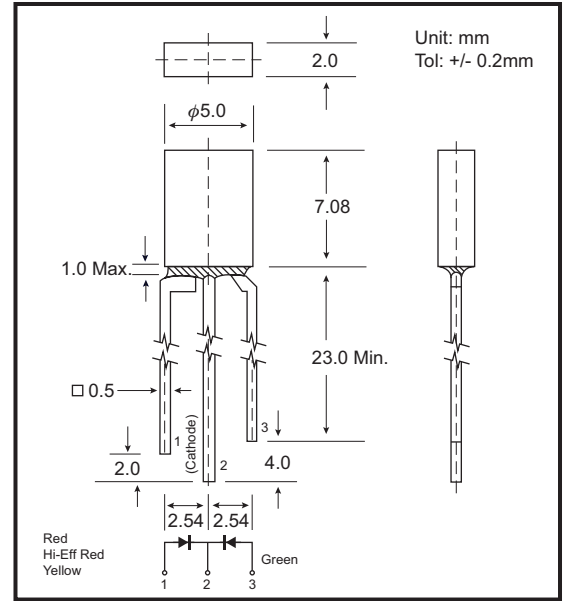

**PART NO. SELECTION AND APPLICATION INFORMATION (RATINGS AT 25°C AMBIENT)**

Part No.	Emitted Color	Lens Color	Peak Wavelength λp (nm)	Vf (v)		Rec. If (mA).	Iv (mcd)		View Angle 2θ1/2(Deg)
				Min	Max		Min	Typ.	
GB-529HGW	Red	White Diffused	697	1.7	2.6	10-20	5.0	8.0	145
	Green	White Diffused	565	1.7	2.6	10-20	6.0	11.0	145
GB-529EGW	Hi-Eff Red	White Diffused	635	1.7	2.6	10-20	8.5	16.0	145
	Green	White Diffused	565	1.7	2.6	10-20	6.0	11.0	145
GB-529YGW	Yellow	White Diffused	585	1.7	2.6	10-20	6.0	11.0	145
	Green	White Diffused	565	1.7	2.6	10-20	11.0	20.0	145

**TESTING CONDITION FOR EACH PARAMETER :**

PARAMETER:	SYMBOL	UNIT	TEST CONDITION
REVERSE VOLTAGE	Vr	VOLT	Vr = 5.0 Volt
REVERSE CURRENT	Ir	µA	If = 20mA
FORWARD VOLTAGE	Vf	VOLT	If = 20mA
LUMINOUS INTENSITY	Iv	MCD	If = 20mA
VIEWING ANGLE	2θ1/2	DEGREE	
RECOMMENDED OPERATING CURRENT	If (Rec)	mA	

